

WE MAKE YOU CHOOSE

BATHROOM FURNITURE

2021



 METALBAN[®]

METALBAN[®]

A METALBAN distingue-se pela conjugação do metal com os diversos acabamentos da madeira, colocando assim uma grande identidade a todos os produtos a serem utilizados nas residências e na hotelaria moderna.

As elegantes estruturas metálicas pintadas, conjugadas com uma variada panóplia de múltiplos acabamentos, funcionando como uma interessante solução de design, permitem articular ambientes mais sofisticados ou e mesmo informais.

Este conceito de mobiliário suspenso e de chão fabricado com recurso nestes dois materiais, resulta numa harmonia pelas proporções definidas para cada material utilizado na sua concepção e levando a um equilíbrio visual perfeito nos ambientes de salas de banho mais inovadoras e actuais.

Metalban se distingue por la combinación del metal con diferentes acabados en madera, proporcionando una identidad propia a todos sus productos pudiendo utilizarse tanto a nivel particular, como en la hostelería moderna.

Las elegantes estructuras metálicas pintadas, combinadas con una variada gama de múltiples acabados en madera, funcionan como una interesante solución de diseño, permitiendo crear ambientes desde los más sofisticados a incluso los más informales.

Este concepto de mobiliario suspendido y para suelo, ofrece una gran armonía debido a las proporciones definidas para cada material utilizado en su concepción y llevando a un equilibrio visual perfecto todos los ambientes de los cuartos de baño, haciéndolos más innovadores y actuales.

Metalban is differentiated by the conjugation of metal with the different finishes of the wood, placing a great identity to all products to be used in residential and modern hotels.

The elegant painted metal structures, combined with a varied panoply of multiple finishes, function as an interesting design solution, allow to articulate more sophisticated or even informal environments.

This concept of suspended and floor furniture, made using these two materials, results in a harmony of the proportions defined for each material used in its design, providing a perfect visual balance in the most innovative and modern bathroom environments.

Metalban se distingue par la conjugaison du metal et diverses finitions bois, donnant de cette façon une grande identité a tous les produits utilisés dans les pensions et dans l'hotellerie moderne.

Les élégantes structures métalliques peintes, conjuguées avec une grande panoplie de multiples finitions en bois, fonctionnant comme une intéressante solution de design, permettent de former des ambiances plus sophistiquées ou et même informelles.

De ce concept de mobilier suspendu et à poser fabriqué avec le recours de ces deux matériaux, résulte une harmonie par les proportions définies de chaque matériel utilisé dans sa conception et qui aboutit sur un équilibre visuel parfait dans l'ambiance de salles de bain plus innovatrices et actuelles.

SIMBOLOGIA

SYMBOLGY | SIMBOLOGÍA | SYMBOLOGIE

M

Outras Medidas Disponíveis
Other Measures Available
Otras medidas disponibles
Autres Mesures Disponibles

SLOW

Gaveta com fecho amortecido
Soft Closing Drawer
Cajón con cierre amortiguado
Tiroir à Fermeture Amortie

SLOW

Porta com fecho amortecido
Soft Closing Door
Puerta con cierre amortiguado
Porte à Fermeture Amortie

LED

Aplique LED
LED Light Fixture
Aplique LED
Luminaire LED

LED STRIP

Fita de LED
LED Strip
Cinta LED
Bande de LED

TUBULAR LIGHT

Lâmpada tubular - G5
Tubular Light Bulb - G5
Lámpara tubular - G5
Ampoule Tube - G5

LEFT / RIGHT

Móvel esquerdo ou direito
Furniture left or right
Mueble izquierdo o derecho
Meuble gauche ou droit

LEFT / RIGHT

Móvel esquerdo ou direito
Furniture left or right
Mueble izquierdo o derecho
Meuble gauche ou droit

LEFT / RIGHT

Móvel esquerdo ou direito
Furniture left or right
Mueble izquierdo o derecho
Meuble gauche ou droit

CLI / CLII

Classes Isolamento Elétrico
Electrical Appliance Classes
Clases Aislamiento Eléctrico
Classes d'appareils électriques

IP 44 / IP 23 / IP 20

Índice de Protecção (IP)
Ingress Protection (IP)
Índice de protección (IP)
L'indice de Protection (IP)

CE

Marcação CE
CE marking
marcado CE
marquage CE

WEEE

Diretiva WEEE
WEEE directive
Directiva WEEE
Directive WEEE

120° / 120° / 30°

Ângulo de luz
Angle of light
Ángulo de luz
Angle de lumière

5700 K

Alcance da luz
Illumination distance
Alcance de la luz
Distance d'illumination

5700 K

Temperatura Cor da Luz - 5700 K
Color Light Temperature - 5700 K
Temperatura de Color Luz - 5700 K
Température de Couleur Éclairage - 5700 K

DRIVER LESS

Driver LED não necessário
LED driver not necessary
Driver LED no necesario
Driver LED non nécessaire

VIBRATION

Sensor de vibração
Vibration sensor
Sensor de vibración
Senseur de vibration

PROXIMITY

Sensor de proximidade
Proximity sensor
Sensor de proximidad
Senseur de proximité

BATTERIES

Pilhas
Batteries
Pilas
Piles

MOVEMENT

Sensor de movimento
Movement sensor
Sensor de movimiento
Décteur de mouvement

PLUG & PLAY

"Ligar e usar"
"Plug & play"
"Enchufar y usar"
"Branche et fonctionne"

VOLTAGE & FREQUENCY

Tensão elétrica e frequência
Electric voltage and frequency
Voltaje eléctrica y frecuencia
Tension électrique et fréquence

MOISTURE

Protecção contra ambientes húmidos
Protection against moist environments
Protección contra ambientes húmedos
Protection contre l'humidité

COLD LIGHT

Luz fria
Cold light
Luz fría
Lumière froide

LED

Diodo emissor de luz
Light emitting diode
Diodo emisor de luz
Diodo électroluminescente

SPOTLIGHT

Foco de luz
Direct light spotlight
Foco de luz
Spot lumineux

15"

Temporizador
timer
temporizador
temporisateur

SCREWS

Parafusos
Screws
Tornillos
Vis

ADHESIVE

Adesivo
Sticker
Adesivo
Autocollant

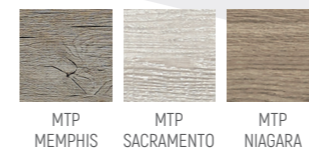

AVANTI L1000

MTP MEMPHIS

(mm)	L	W	H
1	1060	500	770
2	500	360	110
3	1000	35	600



1 **SLOW**

L **R**

3 **LED** **IP 44**





AVANTIR1000



MTP NIAGARA

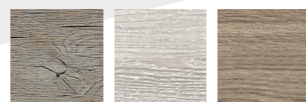

MTP MEMPHIS MTP SACRAMENTO MTP NIAGARA

(mm)	L	W	H
1	1060	500	770
2	600	380	110
3	1000	35	600

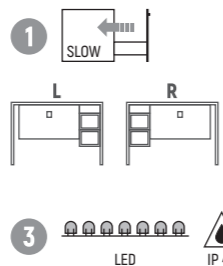
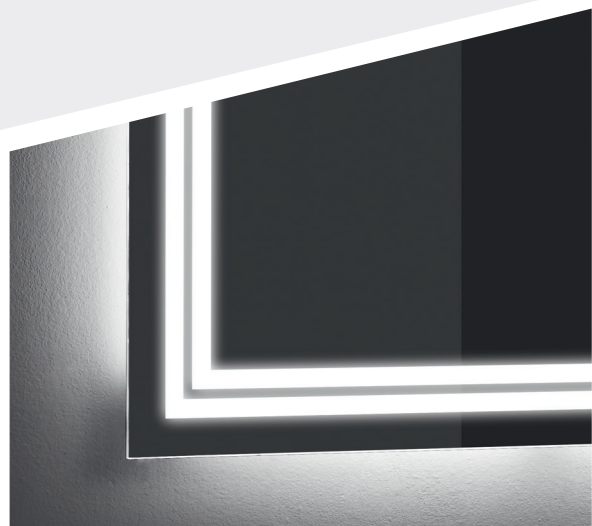

MTP MEMPHIS MTP SACRAMENTO MTP NIAGARA

(mm)	L	W	H
1	1060	500	770
2	400	400	110
3	1000	15	600

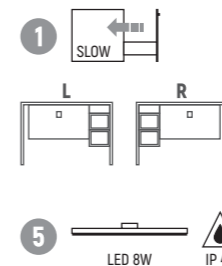

AVANTI L1000

MTP SACRAMENTO





LINKS1000



800 | 1000

MTP ROCK



MTP
ROCK

MTP
WHITE SR

MTP
MEMPHIS

(mm)	L	W	H
1	990	455	650
2	1010	460	20
3	1000	30	800
4	340	340	1360
5	400	100	20

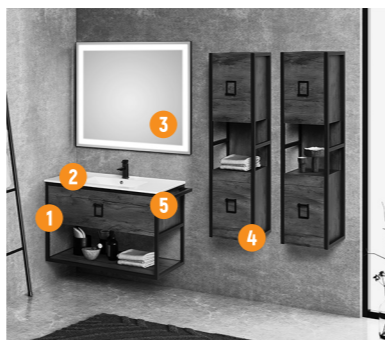
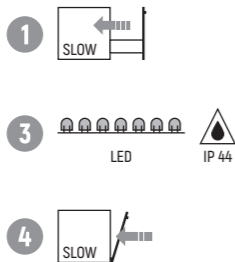

800 | 1000

LINKS800M.I.ESQ.

MTP ROCK



MTP
ROCK

MTP
WHITE SR

MTP
MEMPHIS

(mm)	L	W	H
1	790	455	650
2	810	460	20
3	800	25	800
4	340	340	1360

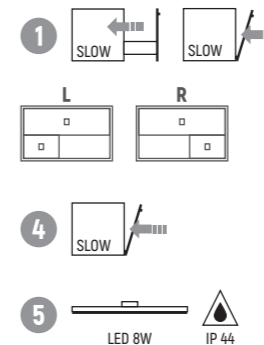



LINK S 800 M.I.DIR.

MTP MEMPHIS



800 | 1000



MTP ROCK MTP WHITE SR MTP MEMPHIS

(mm)	L	W	H
1	790	455	650
2	810	460	20
3	800	35	600
4	340	340	1360
5	400	100	20

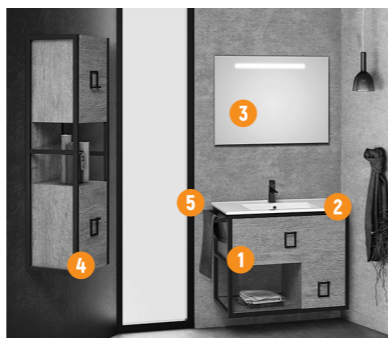
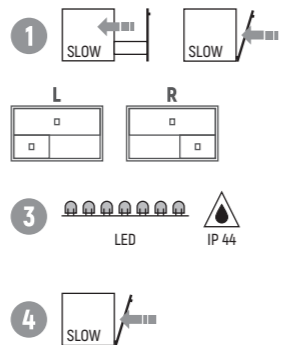

MTP ROCK MTP WHITE SR MTP MEMPHIS

(mm)	L	W	H
1	790	455	850
2	810	460	20
3	800	25	800
4	340	340	1360

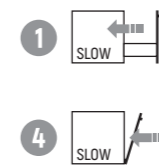

LINK P 800

MTP ROCK



800 | 1000





LINK P1000 M.I.DIR.

MTP WHITE SR



800 | 1000



MTP ROCK

MTP WHITE SR

MTP MEMPHIS

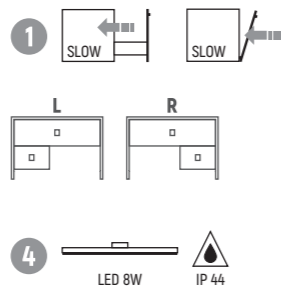

(mm)	L	W	H
1	990	455	850
2	1010	460	20
3	1000	25	800



800 | 1000

PLAY 2G800

MTP ROCK



MTP ROCK

MTP WHITE SR

MTP MEMPHIS

(mm)	L	W	H
1	790	455	850
2	810	460	20
3	800	25	800
4	340	340	1360

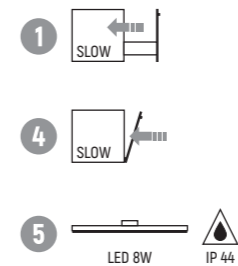



PLAY2G1000



800 | 1000

MTP MEMPHIS



MTP ROCK

MTP WHITE SR

MTP MEMPHIS

(mm)	L	W	H
1	990	455	850
2	1010	460	20
3	1000	30	800
4	340	340	1360

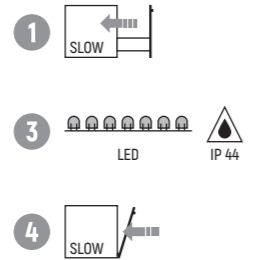
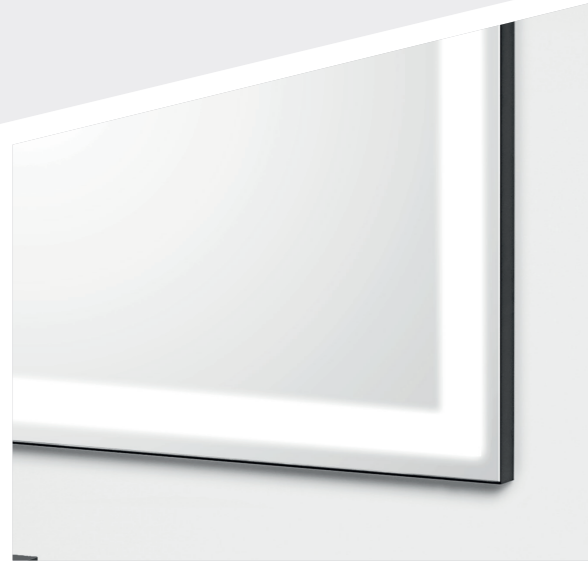

MTP ROCK

MTP WHITE SR

MTP MEMPHIS

(mm)	L	W	H
1	990	455	850
2	1010	460	20
3	1000	30	600
4	340	340	1360

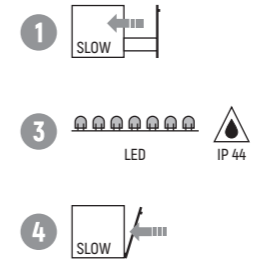

PLAY3G1000

800 | 1000

MTP WHITE SR





KATUS800



MTP HERCULES

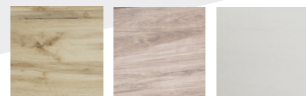

MTP HERCULES MTP COLORADO MTP VIRGINIA

(mm)	L ↔	W ↗	H ↓
1	800	455	500
2	380	380	130
3	600	30	800
4	340	340	1360
5	300	255	730

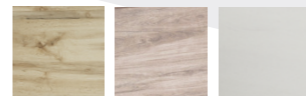
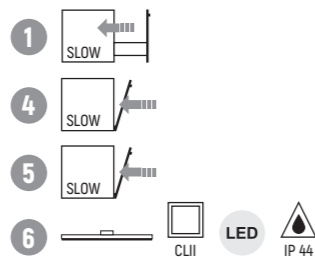

MTP HERCULES MTP COLORADO MTP VIRGINIA

(mm)	L ↔	W ↗	H ↓
1	990	455	500
2	380	380	130
3	600	30	800
4	300	255	730

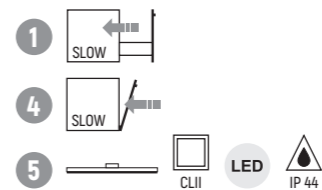
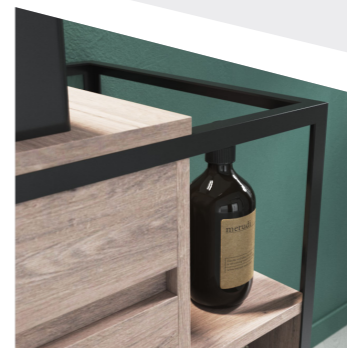

KATUS1000

MTP COLORADO



KATUS1200

MTP VIRGINIA



(mm)	L	W	H
1	1200	455	500
2	380	380	130
3	400	30	800
4	340	340	1360

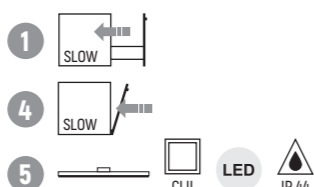

ESPELHOS COM ILUMINAÇÃO INTEGRADA | MIRRORS WITH INTEGRATED LIGHTING

ESPEJOS CON ILUMINACIÓN INTEGRADA | MIROIRS AVEC ÉCLAIRAGE INTÉGRÉ

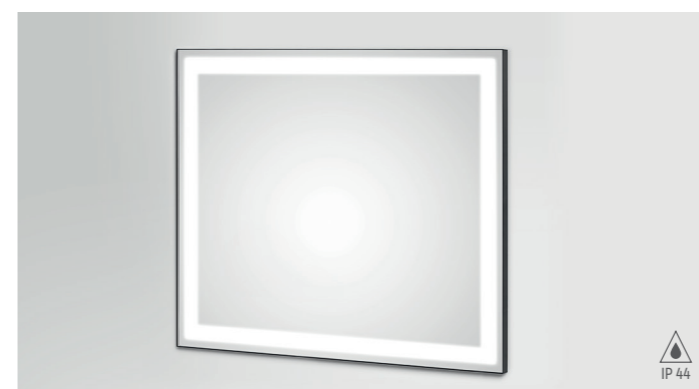

METLINE LED	LxWxH (mm)	LED
	600x30x800	21W
	800x30x800	25W
	1000x30x800	29W
	1200x30x800	42W



FLUX	LxWxH (mm)	LED
	600x35x600	6W
	800x35x600	10W
	1000x35x600	12W
	1200x35x600	12W



TODAY	LxWxH (mm)	LED
	800x30x600	23W
	1000x30x600	27W
	1200x30x600	31W

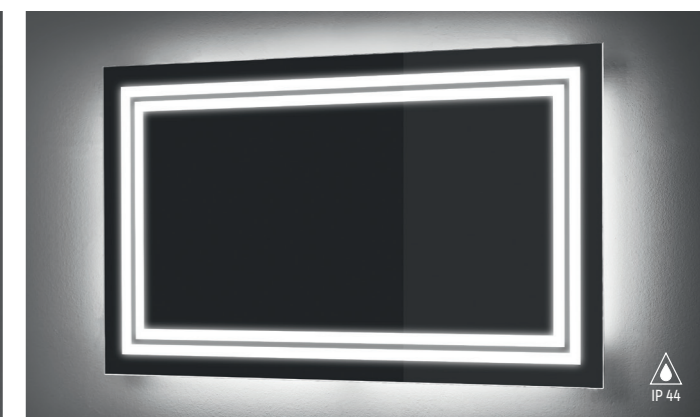

TRENDY	LxWxH (mm)	LED
	600x35x800	20W
	800x35x600	20W
	1000x35x600	24W
	1200x35x600	27W

ESPELHOS SEM ILUMINAÇÃO INTEGRADA | MIRRORS WITHOUT INTEGRATED LIGHTING

ESPEJOS SIN ILUMINACIÓN INTEGRADA | MIROIRS SANS ÉCLAIRAGE INTÉGRÉ



METLINE	LxWxH (mm)
	400x30x800
	600x30x800
	800x30x800
	1000x30x800
1200x30x800	



LINK	LxWxH (mm)
	800x25x800
	1000x25x800
	1200x25x800



JUST	LxWxH (mm)
	400x15x800
	800x15x600
	1000x15x600
1200x15x600	

APLIQUES | SPOT LIGHTING FIXTURES | APLIQUES | SPOTS D'ÉCLAIRAGE

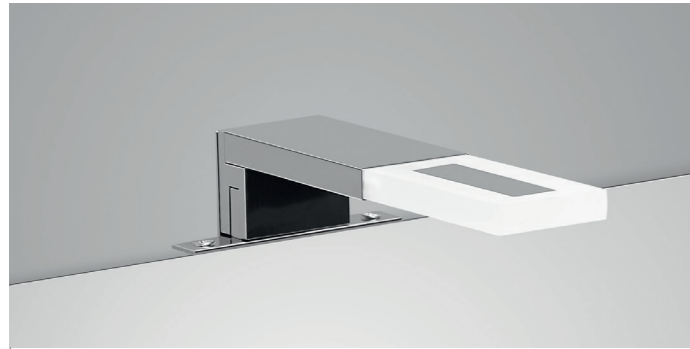

TODAY LED 5W

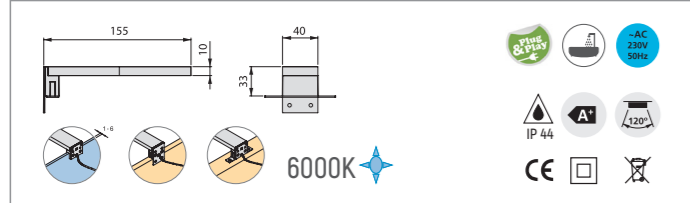

5W ; 30LED ; 380lm | Chrome

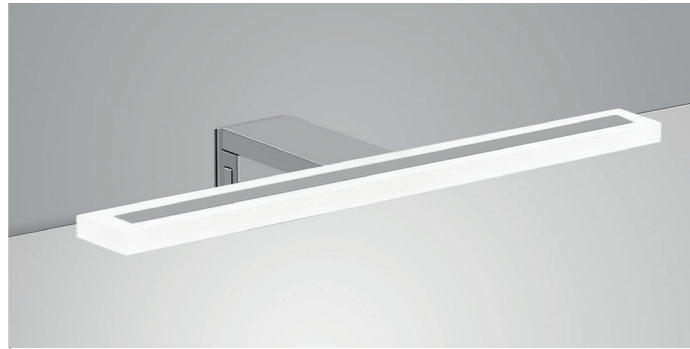

TODAY LED 7W

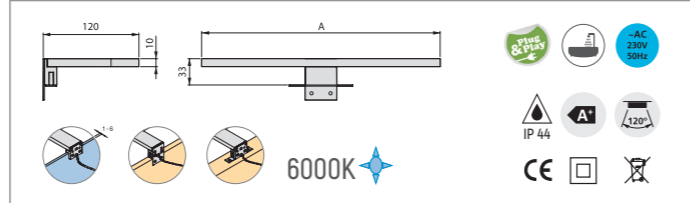

7W ; 60LED ; 550lm ; | Chrome (A=300mm)



LATTO LED 8W

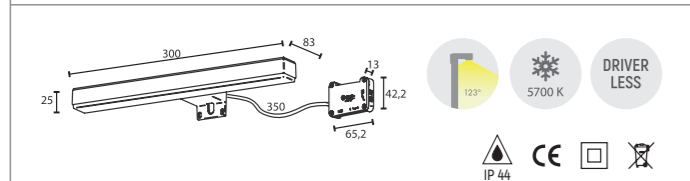

8W ; 525lm ; | Chrome

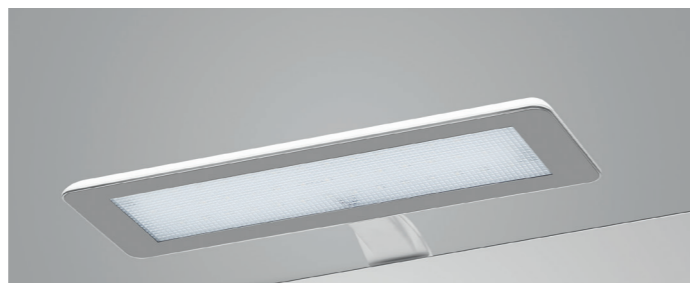

REFLEX LED 10W

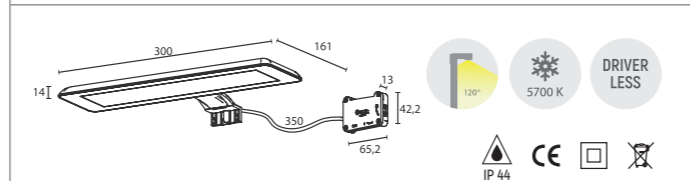

10W ; 1870lm ; | White/Chrome

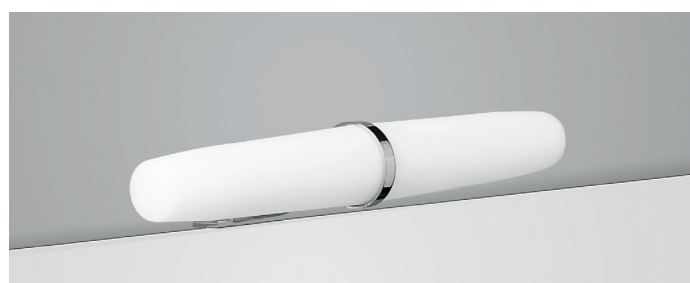

TUBUS LED 6W

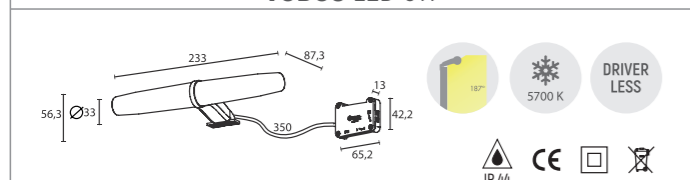

6W ; 720lm ; | Chrome



CELY LED 6W

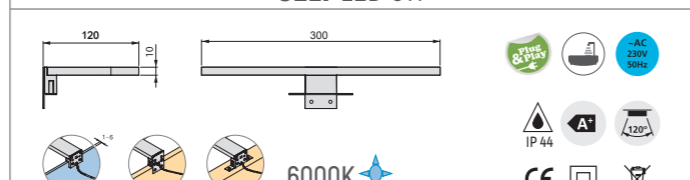



6W ; 60LED ; 550lm | Black

LAVATÓRIOS | WASH HAND BASIN | LAVABOS | LAVABOS

Cerâmico | Ceramic | Cerámica | Céramique

HILTON	LxWxH (mm)	AVANTI	LINK	PLAY	KATUS
	810x460x20		●	●	
	1010x460x20		●	●	

LUPY	LxWxH (mm)	AVANTI	LINK	PLAY	KATUS
	500x360x110		●		

FUNNY	LxWxH (mm)	AVANTI	LINK	PLAY	KATUS
	600x380x110		●		

BELLO	LxWxH (mm)	AVANTI	LINK	PLAY	KATUS
	500x360x110		●		

ROUNDY	LxWxH (mm)	AVANTI	LINK	PLAY	KATUS
	450x150		●		

FENIX gloss . matt	LxWxH (mm)	AVANTI	LINK	PLAY	KATUS
	380x380x130	●			●

FENIX matt	LxWxH (mm)	AVANTI	LINK	PLAY	KATUS
	380x380x130				●

SIGN	LxWxH (mm)	AVANTI	LINK	PLAY	KATUS
	410x410x140	●			

TRENDY	LxWxH (mm)	AVANTI	LINK	PLAY	KATUS
	450x400x100	●			

FLEX	LxWxH (mm)	AVANTI	LINK	PLAY	KATUS
	390x390x160	●			

GLAM	LxWxH (mm)	AVANTI	LINK	PLAY	KATUS
	560x430x130	●			

ACESSÓRIOS | ACCESSORIES | ACCESORIOS | ACCESSOIRES

TOALHEIRO | TOWEL RACK | TOALLERO | PORTE-SERVLETTE

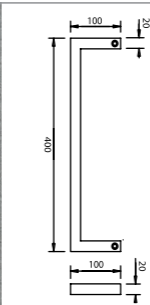

LINK	MTP	AVANTI	LINK	PLAY	KATUS
			●	●	



ILUMINAÇÃO | LIGHTING | ILUMINACIÓN | ÉCLAIRAGE

MOVE LED	AVANTI	LINK	PLAY	KATUS
<p>MOVE LED Foco LED com sensor de proximidade LED spotlight with proximity sensor Foco LED con sensor de proximidad Spot LED avec senseur de proximité</p>  <p>0,42 W ; 56 lm 6500K</p> <p>LED IP20 30° ON/OFF 15° 3 x LR03 AAA SENSOR MOTION</p>	●	●	●	

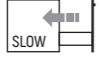
SHAKE LED	AVANTI	LINK	PLAY	KATUS
<p>SHAKE LED Foco LED com sensor de vibração LED spotlight with vibration sensor Foco LED con sensor de vibración Spot LED avec senseur de vibration [Para Gavetas ; for drawers ; para cajones ; pour tiroirs]</p>  <p>0,6 W ; 28 lm 7000K</p> <p>LED IP20 140° ON/OFF 15° 3 x LR03 AAA</p>	●	●	●	

GAVETAS | DRAWERS | CAJONES | TIROIRS

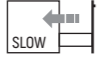
GAV6.0  	AVANTI	LINK	PLAY	KATUS
	●	●	●	●

GAV3.0  	AVANTI	LINK	PLAY	KATUS
	●	●	●	●

MATERIAIS | MATERIALS | MATERIALES | MATÉRIAUX

ASMM 	Aglomerado Superpan Melamina Madeiras Particleboard Superpan Wood Melamine Tablero de Partículas Superpan Melamina Maderas Panneau de Particules Superpan Mélangine Bois	AVANTI	LINK	PLAY	KATUS
		●	●	●	●

MP 	Estrutura metálica com pintura zinco + poliéster preto Metal structure with zinc paint + polyester black Estructura metálica con pintura zinc + poliéster negro Structure en métal avec peinture au zinc + polyester noir	AVANTI	LINK	PLAY	KATUS
		●	●	●	●

ACABAMENTOS | FINISHINGS | ACABADOS | FINITIONS



MTP
MEMPHIS
AVANTI | LINK | PLAY



MTP
SACRAMENTO
AVANTI



MTP
NIAGARA
AVANTI



MTP
ROCK
LINK | PLAY



MTP
WHITE SR
LINK | PLAY



MTP
HERCULES
KATUS

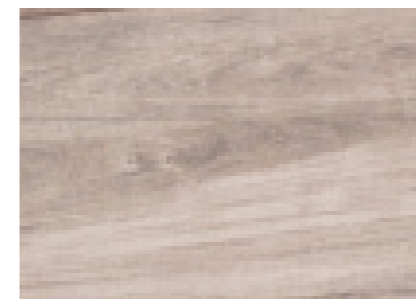

MTP
COLORADO
KATUS

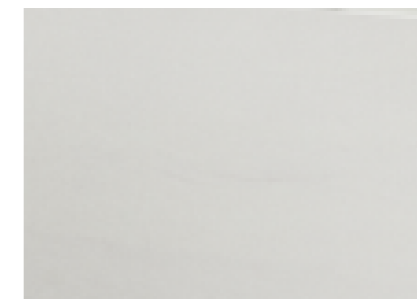

MTP
VIRGINIA
KATUS

The logo for METALBAN, featuring a stylized orange and grey cube icon to the left of the company name.

METALBAN[®]

Rua Alto do Vale do Grou, N°460
Nova Borralha
Z.I. EN 1 Sul
3750-870 Borralha
Águeda - PORTUGAL

GPS: 40° 32' 41" N 8° 26' 24" W

Tel.: +351 234 690 120
Fax.: +351 234 690 129

eban@eban.pt
www.eban.pt